

6-20 mm
0.2-0.8 in

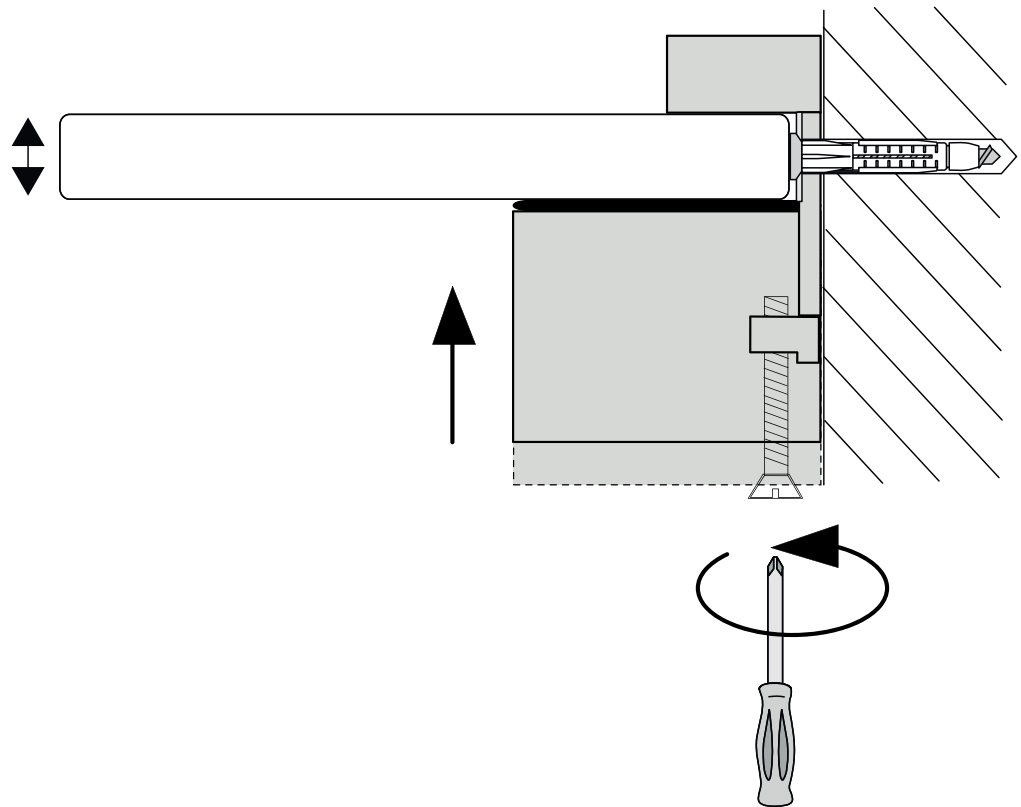

PZ 2 $\varnothing 4.5 \times 45$ mm
#10x1.8 in

$\varnothing 6 \times 36$ mm
#8-10x1.4 in

$\varnothing 6$ mm
15/64 in

